



SPECTRA® SAFETY TREADS

SPECTRA® TREADS PROVIDE:

A high content of aluminum oxide abrasive grit for long life and lasting beauty. Spectra's safety surface has easy maintenance features and insures greatest protection from liability of falls and injuries.

SPECTRA® FEATURES:

- Extruded aluminum base - abrasive filler
- Lengths to order – up to 10'-0" max in one piece
- Lengths over maximum to be made in equal sections
- Anti-slip abrasive extending over radius of nose
- High content of aluminum oxide abrasive
- 18 standard colors - Colors extend throughout filler
- Clean architectural lines
- Protective tape available at additional cost
- Noncombustible



SPECTRA® SPECIFICATION:

- Provide Spectra® type **WP4C** safety nosings as manufactured by Wooster Products Inc. for interior and exterior stairs.
- Tread base shall be type 6063-T5 extruded aluminum.
- Anti-slip filler shall contain not less than 60% virgin grain Aluminum Oxide (Al_2O_3) abrasive.
- Binder is to be a fully cured resilient type epoxy; epoxy binder to filler ratio to be 13% minimum for improved cleanability.
- Epoxy/Abrasive filler shall be securely bonded to the extruded aluminum base.
- Type of anchor shall be specified.
- Treads may terminate 4" from ends of steps for poured concrete stairs; for concrete filled pan stairs, nosings shall be full length of steps less 1/8" clearance.
- Color shall extend uniformly throughout the filler; black color will be furnished if no other color is specified.
- Protective tape available upon request at additional cost.
- Protective tape should be removed as soon as possible once installed.

Type WP4C

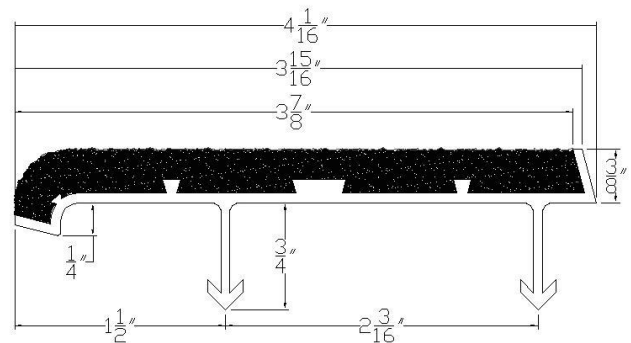

4 1/16" wide, 3/8" thick, nose 1/4" underside
DRAWING NOT TO SCALE
Maximum length is 10'-0".

GUIDELINES FOR THE INSTALLATION OF METAL SAFETY TREADS OR NOSINGS INTO NEW CONCRETE OR STEEL PAN FILLED STAIRS:

- The use of very large aggregate in the concrete mix may make placement of the safety nosing difficult.
- Safety nosing placement may be difficult in concrete with very low slump.
- Place concrete into the stair forms or steel pans as quickly as possible; schedule pour so as to install the metal safety nosings quickly before the initial set of concrete occurs.
- Puddle the concrete, tamp the safety nosings to insure proper concrete formation around the anchors.
- Remove protective tape (if used) as soon as practical.
- Order nosings or treads well in advance of the pour or installation date.
- Close Stairway after pour; permit no use for 24 hours.

WOOSTER PRODUCTS INC, 1000 SPRUCE ST., WOOSTER, OH 44691

Toll Free: 800-321-4936

Phone: 330-264-2844

Fax: 330-262-4151

Website: <http://www.woosterproducts.com>

E-mail: sales@wooster-products.com